

NOMBRE: \_\_\_\_\_

FECHA: \_\_\_\_\_

# INVIERNO

## Vocabulario y actividades

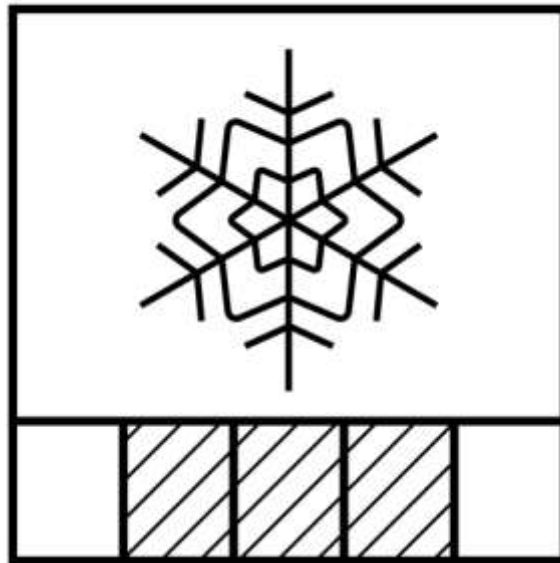

Lola García Cucalón

# LECTURA

# INVIERNO

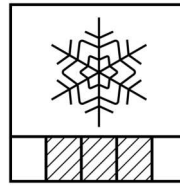

Después del  llega el .

Los  se quedan sin .

Hace mucho , nieva  y

hiela .

Nos ponemos ropa de abrigo: 

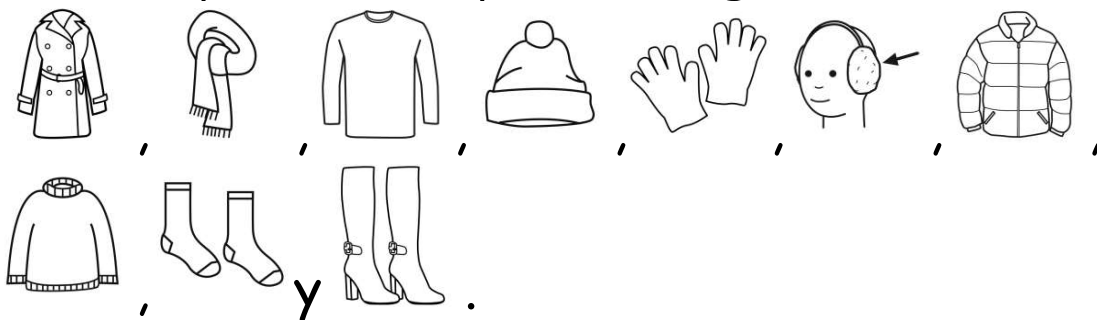

Practicamos deportes de :

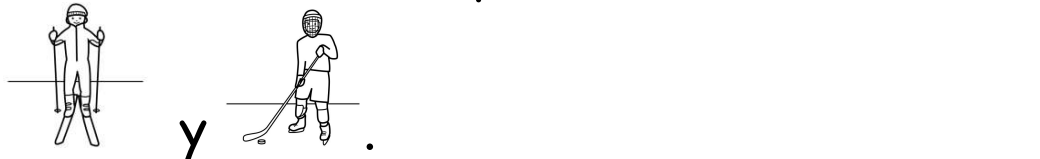

Cuando  mucho, pasa la  a  
limpiar la  y hacemos .  
Encendemos la ,  y  para  
que la  esté calentita.

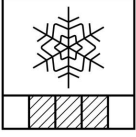
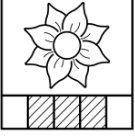
Después del  llega la .

# VOCABULARIO

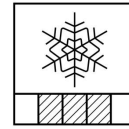
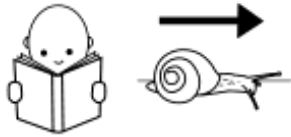

### Lee despacio

 <p><b>INVIERNO</b></p>	 <p><b>FRÍO</b></p>	 <p><b>QUITANIEVES</b></p>
 <p><b>HIELO</b></p>	 <p><b>NIEBLA</b></p>	 <p><b>NIEVE</b></p>
 <p><b>CHIMENEA</b></p>	 <p><b>MANTA</b></p>	 <p><b>ESTUFA</b></p>
 <p><b>PATINAJE</b></p>	 <p><b>ESQUÍ</b></p>	 <p><b>HOCHEY</b></p>

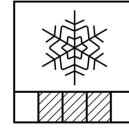

### Lee despacio









 <b>ABRIGO</b>	 <b>PLUMÍFERO</b>	 <b>CHAQUETÓN</b>
 <b>JERSEY</b>	 <b>CAMISETA</b>	 <b>BUFANDA</b>
 <b>MANOPLAS</b>	 <b>GUANTES</b>	 <b>GORRO</b>
 <b>OREJERAS</b>	 <b>CALCETINES</b>	 <b>BOTAS</b>

# AUTODICTADOS

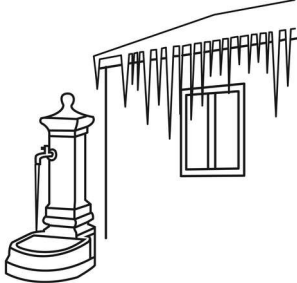

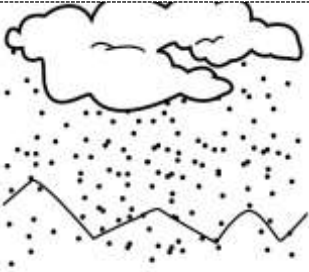



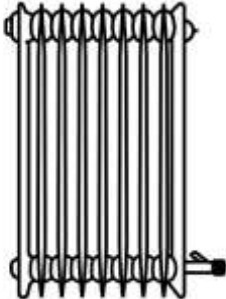



		
PATINAJE	ESQUÍ	HOCKEY
		
ESQUIS	TRINEO	QUITANIEVES
		
PISTA	PISTA	PATINES
		
BOTAS	TELECABINA	TELESILLA

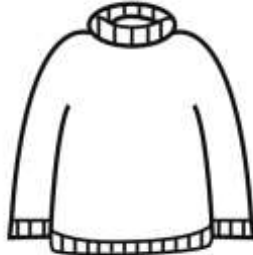

				
MUÑECO	FRÍO	QUITANIEVES	HELADA	NIEBLA
				
NIEVE	CHIMENEA	MANTA	ESTUFA	RADIADOR

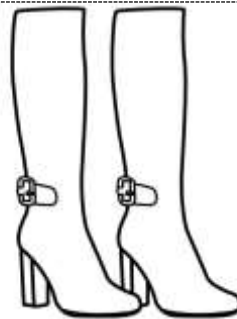

				
BUFANDA	GORRO	GUANTES	OREJERAS	JERSEY
				
ABRIGO	PLUMIFERO	LEOTARDOS	CALCETINES	BOTAS



# TEMPORALIDAD

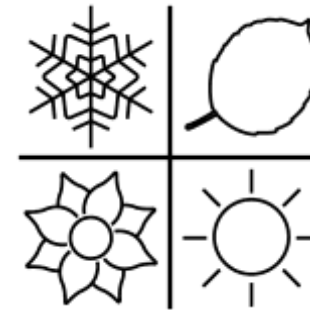

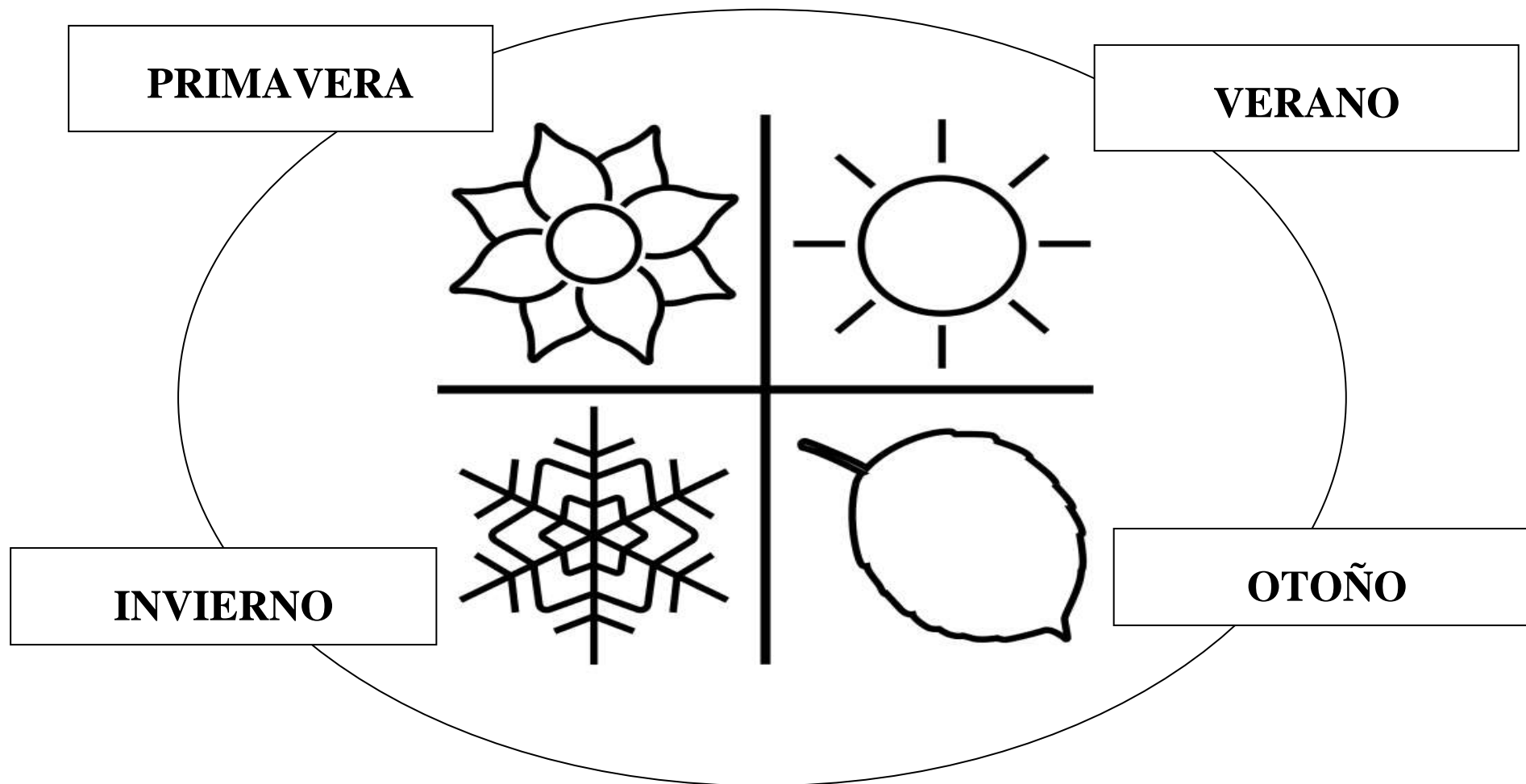

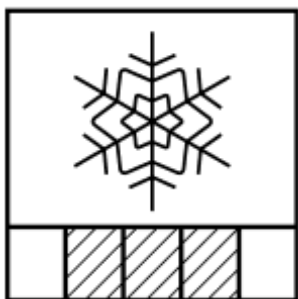

**PRIMAVERA**

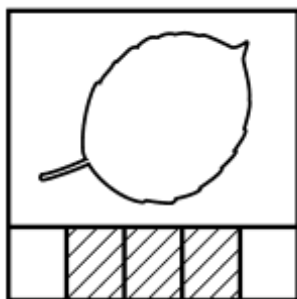

**VERANO**

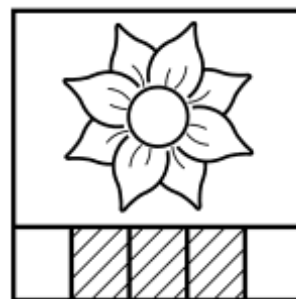

**OTOÑO**

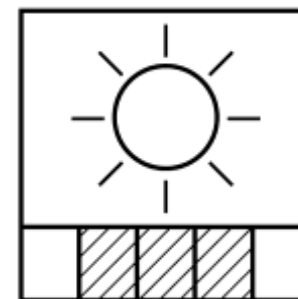

**INVIERNO**

# EXPRESIÓN

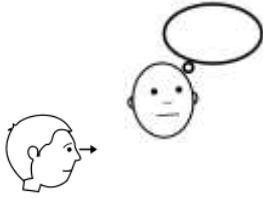

¿En qué se parecen?  
¿En qué se diferencian?

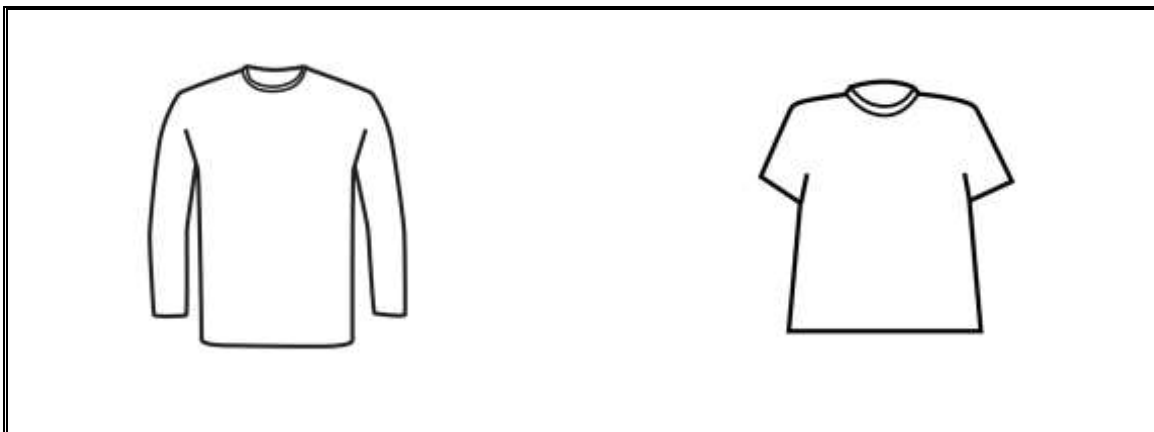
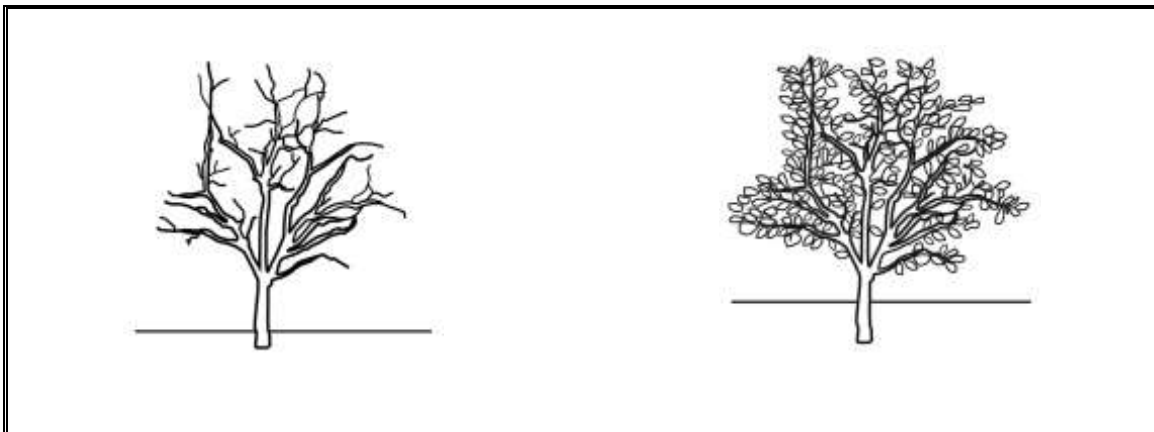
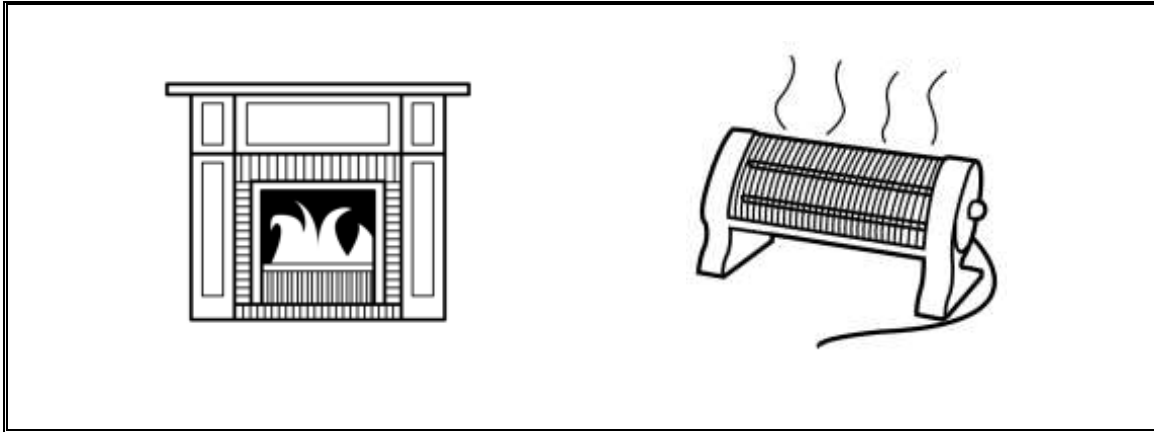
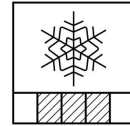



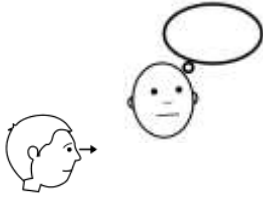

¿En qué se parecen?  
¿En qué se diferencian?

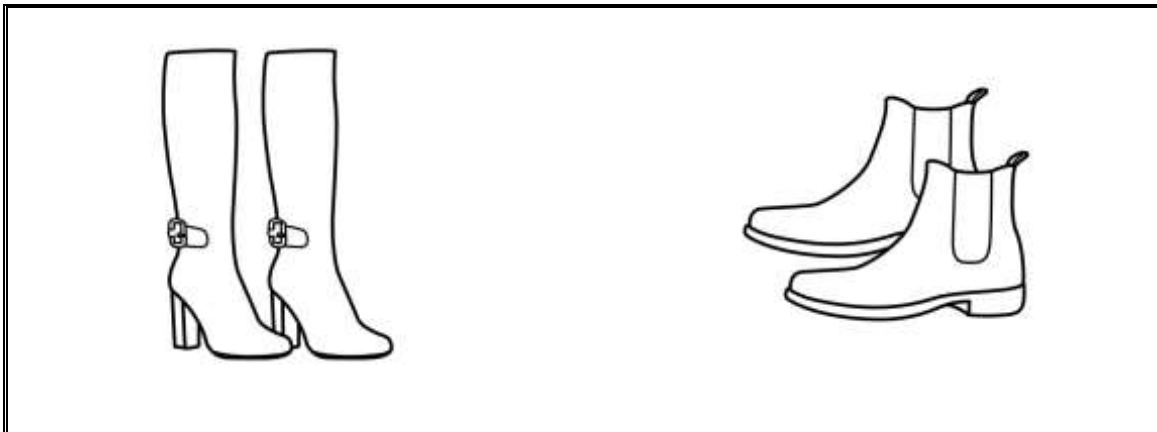
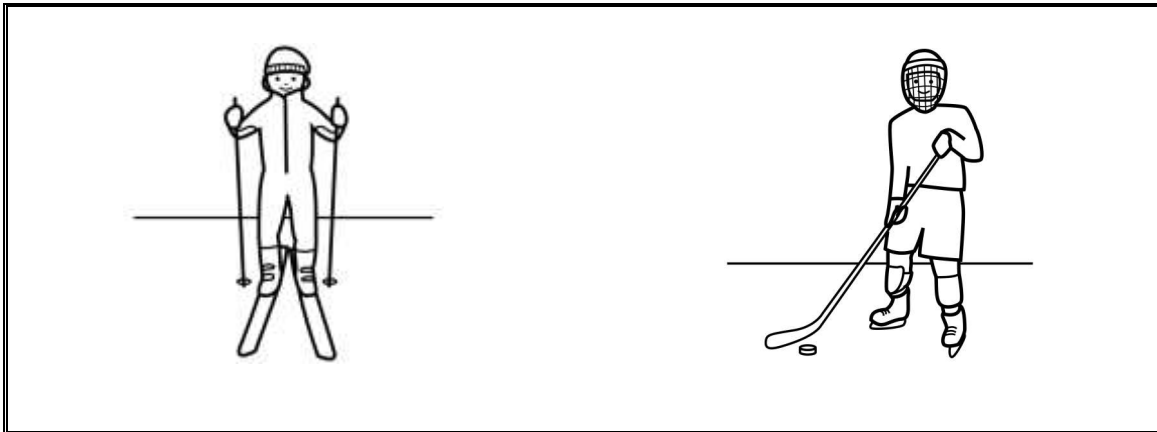
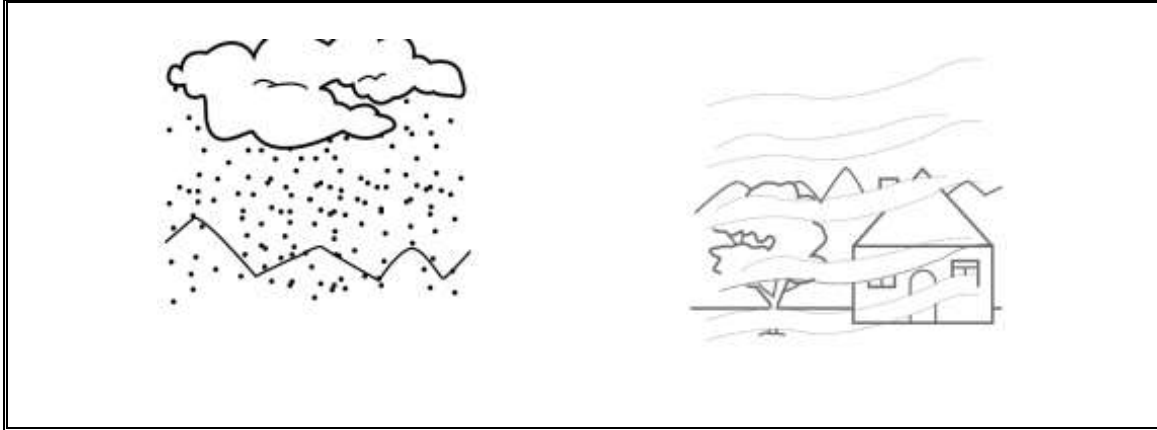
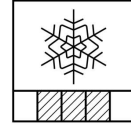

# FICHAS



Tacha el elemento que no pertenece al grupo

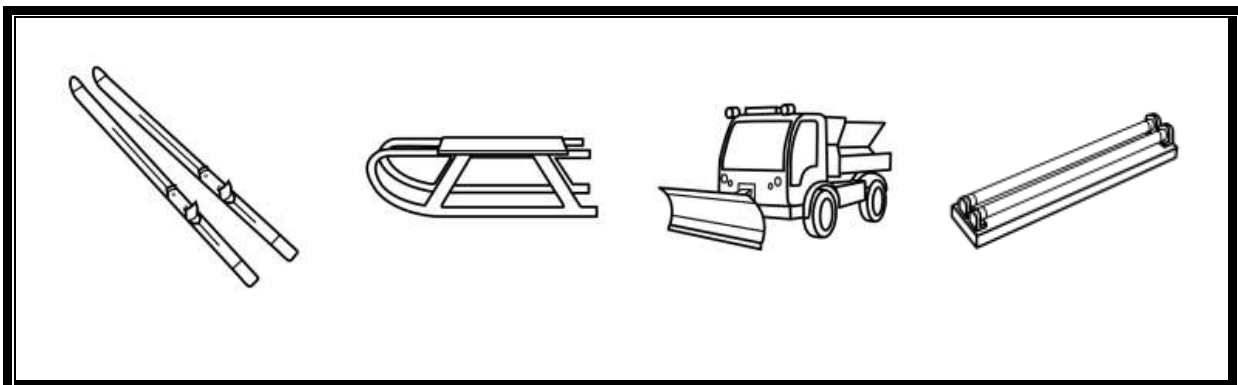
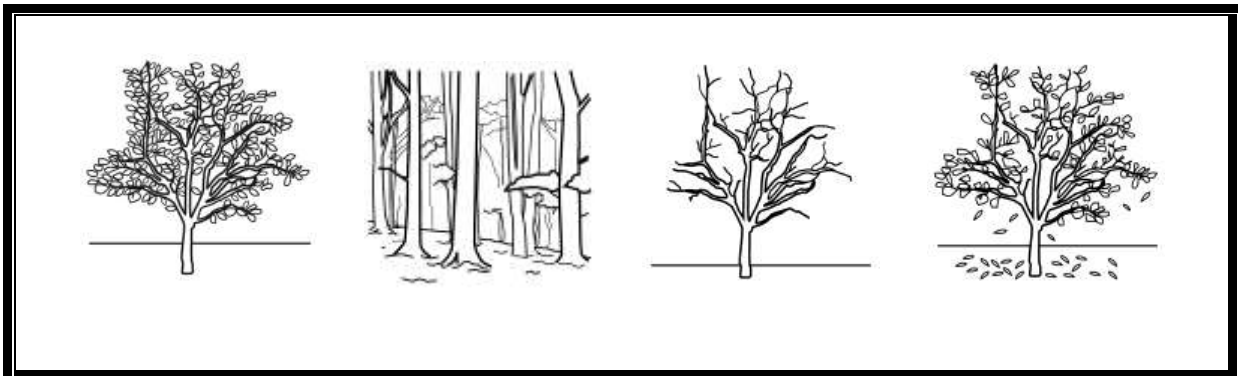
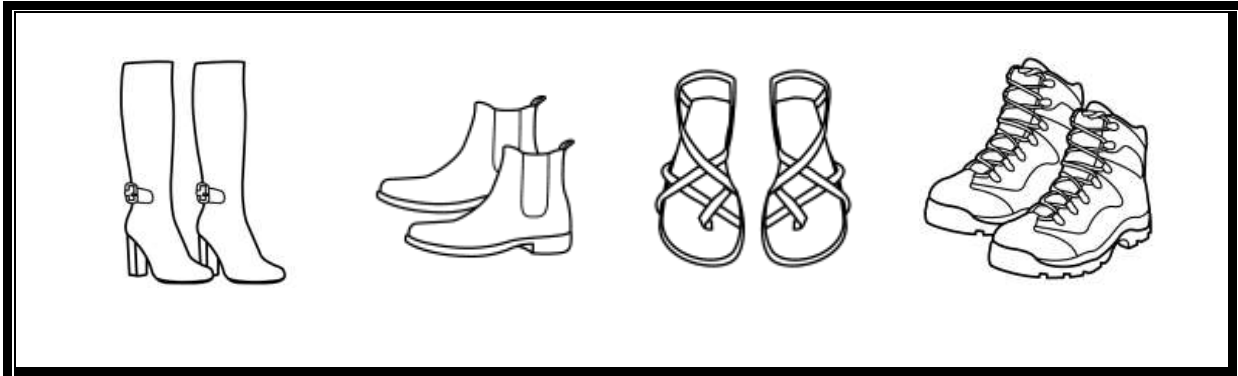
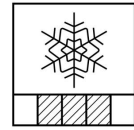



Busca y rodea los que sean igual

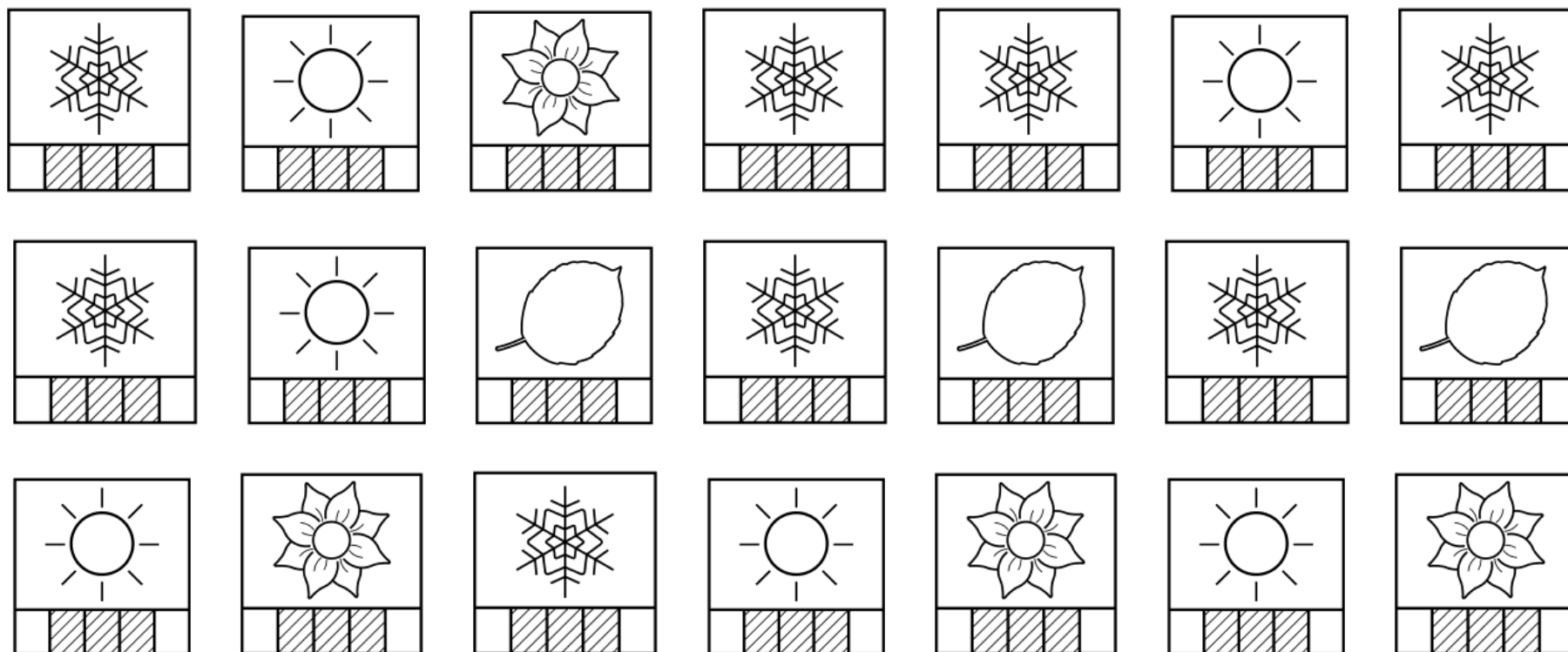
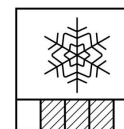

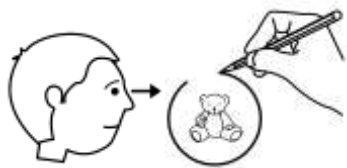

Busca las diferencias y rodéalas



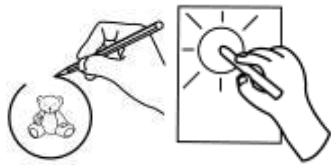

Rodea y pinta las cosas relacionadas con el invierno

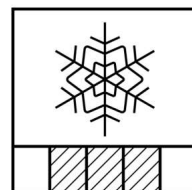
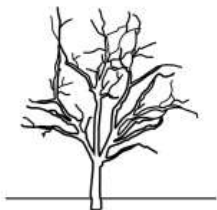
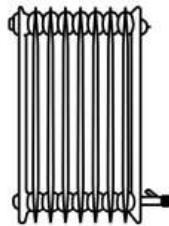
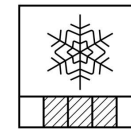

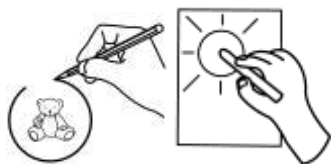

## Rodea y pinta las prendas de invierno

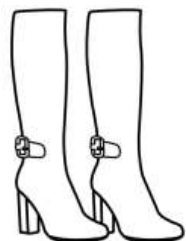
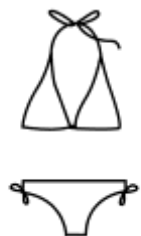
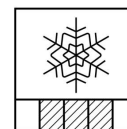





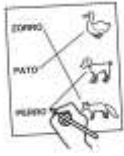

Une con flechas

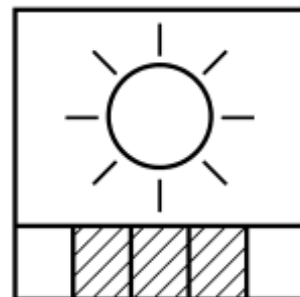
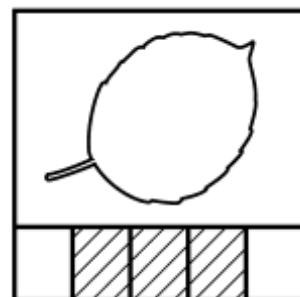
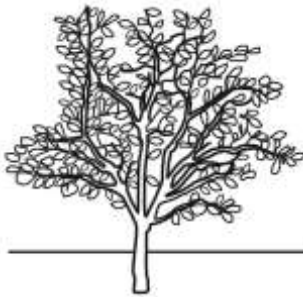
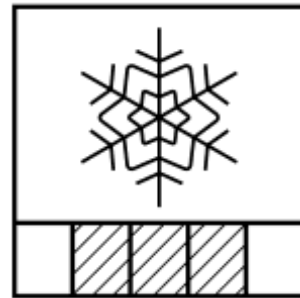
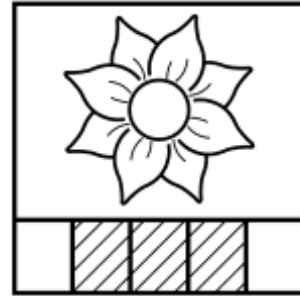
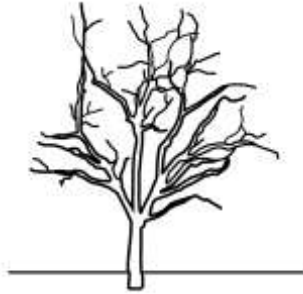

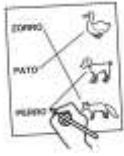

Une con flechas

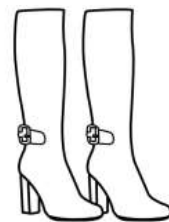
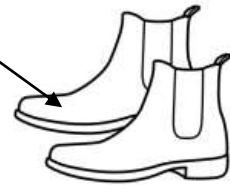
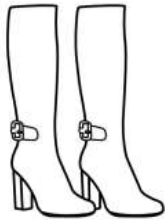
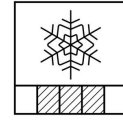

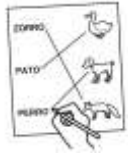

Une con flechas

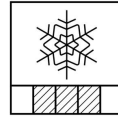

NIEVE



LLUVIA



HIELO

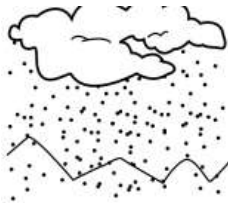

VIENTO



NIEBLA



Piensa y completa las palabras

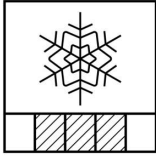
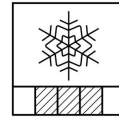

\_nv\_\_rn\_\_



\_st\_f\_\_



p\_st\_\_



m\_nt\_\_

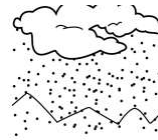

n\_\_v\_\_



ch\_m\_n\_\_



ll\_v\_\_

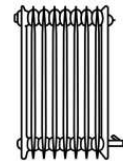

r\_d\_\_d\_r



n\_\_v\_\_



h\_\_l\_\_



qu\_t\_n\_\_v\_s



n\_\_bl\_\_



tr\_n\_\_

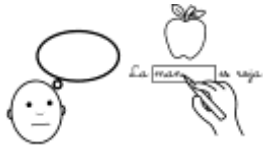

Piensa y completa las palabras

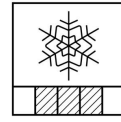

\_br\_g\_



g\_\_nt\_s



b\_f\_nd\_



g\_rr\_



j\_rs\_y



m\_n\_pl\_s



c\_m\_s\_t\_



ch\_qu\_t\_n



l\_\_t\_rd\_s



\_r\_j\_r\_s



c\_lc\_t\_n\_s



p\_nt\_l\_n

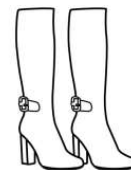

b\_t\_s



Escribe el nombre

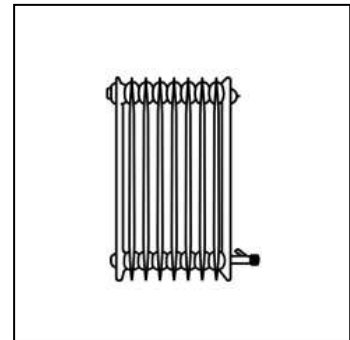
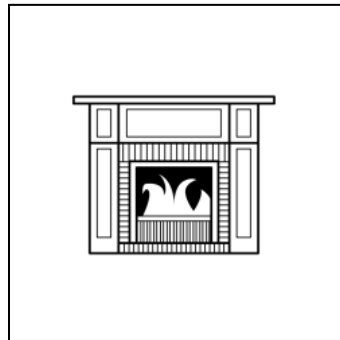
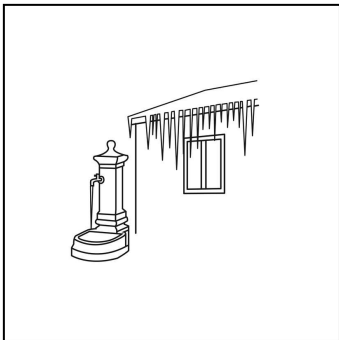
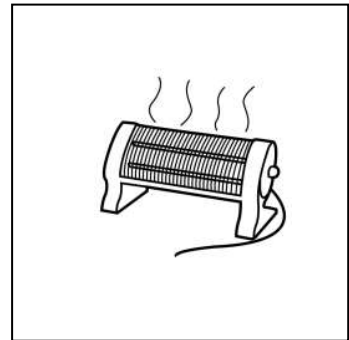
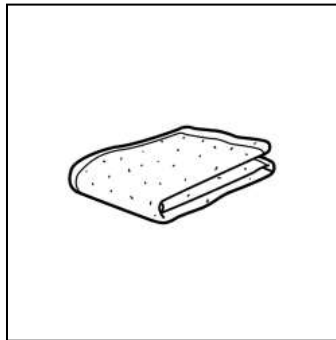
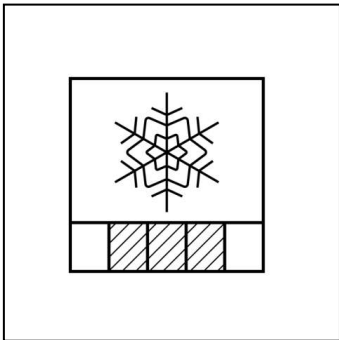
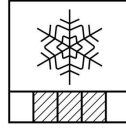



Escribe el nombre

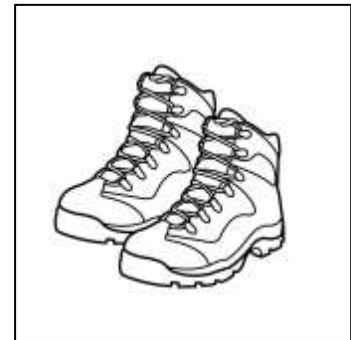
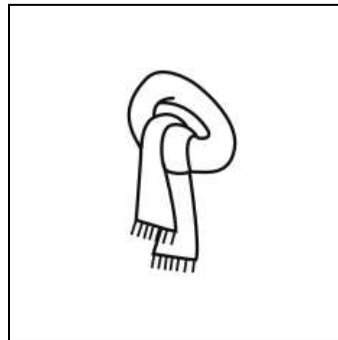
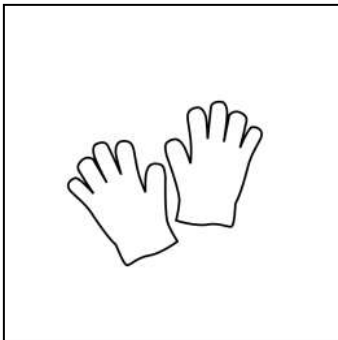
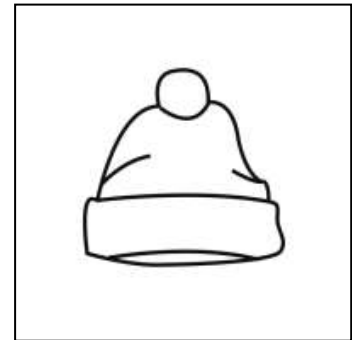
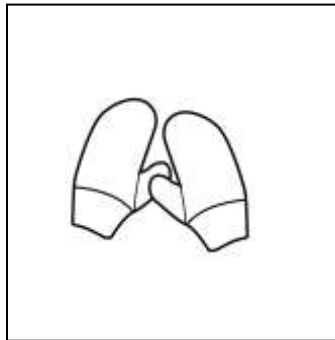
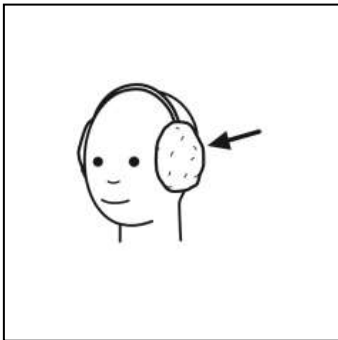
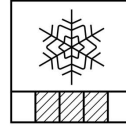



## Adivina

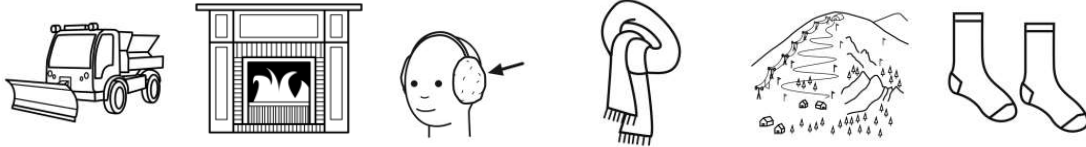

Es blanca y cae del cielo .....

Quita la nieve de las carreteras: .....

Para proteger la garganta del frío: .....

Estación del año en que hace mucho frío .....

Lugar donde se sube a esquiar .....

Nos abriga las orejas: .....

Sirve para proteger las manos .....

Por donde baja papá Noel .....

Prenda de vestir de lana: .....

Prenda que se pone en los pies: .....

Para deslizarnos por la nieve .....

Lo enchufamos para calentar la casa: .....

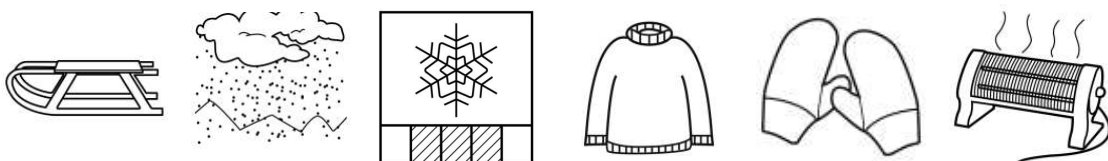





Pinta y dibuja siguiendo las indicaciones

---

- La camiseta es naranja.
- A la derecha está la portería.
- Encima del marcador hay un ratón.
- El pantalón es verde.
- Las rodilleras son moradas.
- Entre los patines se está rompiendo el hielo.





Pinta y dibuja siguiendo las indicaciones

---

- La pared de la casa es marrón.
- El día está soleado
- Han dejado un cubo al lado de la fuente.
- La fuente es gris.
- El cristal de la ventana está roto
- Hay tres troncos grandes debajo de la ventana.

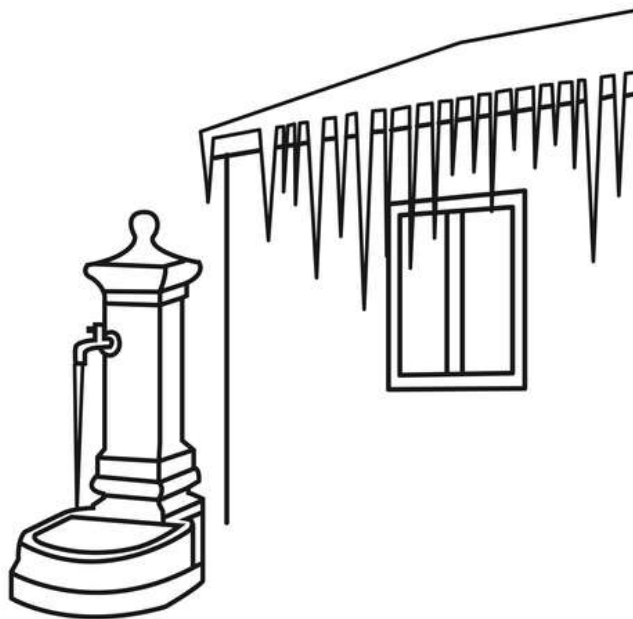



## Observa los dibujos y contesta

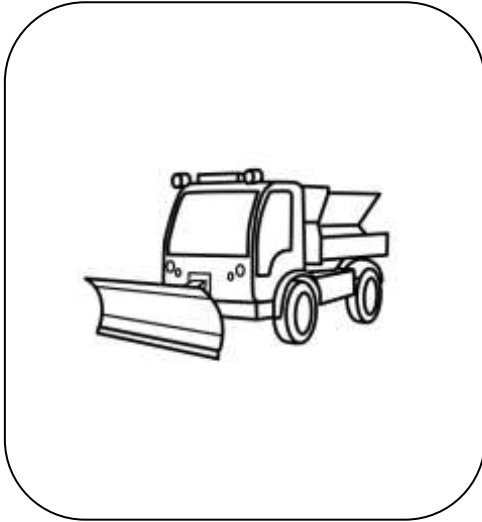
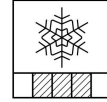

¿Qué es?

---

¿Para qué sirve?

---

---

¿Has visto alguna?

---

¿Qué es?

---

¿Para qué sirve?

---

¿Dónde se encuentran?

---

¿Has montado alguna vez?

---





## Observa los dibujos y contesta

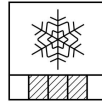

¿Qué deporte es?

\_\_\_\_\_

¿Qué se necesita?

\_\_\_\_\_

\_\_\_\_\_

¿Te gustaría practicarlo?

\_\_\_\_\_

¿Qué deporte es?

\_\_\_\_\_

¿Qué se necesita?

\_\_\_\_\_

\_\_\_\_\_

¿En qué estación se practica?

\_\_\_\_\_

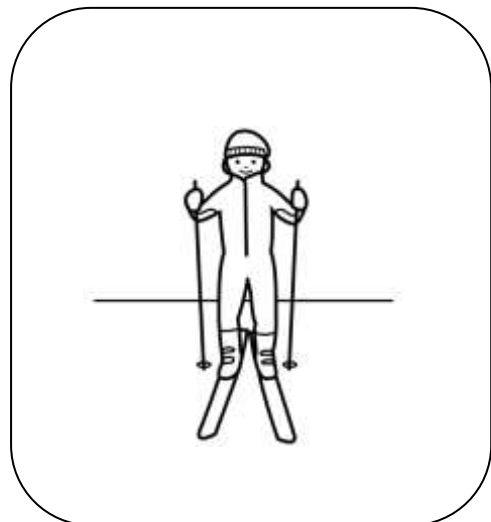

*Invierno*